

CE
0297

PEOPLE HAVE PRIORITY

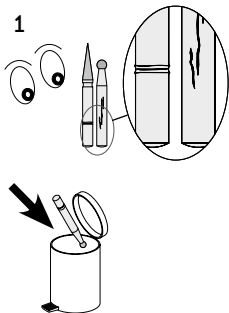

Bur gauge
REF 02139800



2

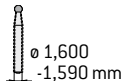
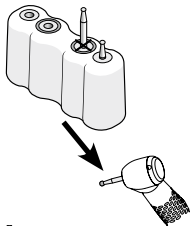
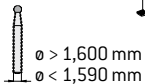
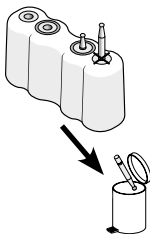

OK!

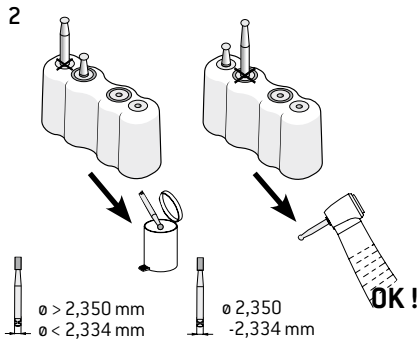
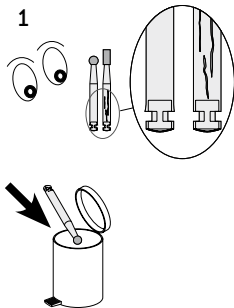

Manufacturer

W&H Dentalwerk Bürmoos GmbH
Ignaz-Glaser-Straße 53, 5111 Bürmoos, Austria

t + 43 6274 6236-0, f + 43 6274 6236-55
office@wh.com wh.com

Form-Nr. 50580 AMS
Rev. 002 / 28.01.2014
Subject to alterations